

JRS REPAIR PARTS

Item No.	Part Description	Material	Repair Part No.				
			JRS5	JRS5H	JRS5LT	JRS7	JRS10
1	Drain plug ¼" NPT	Steel	6K2				
2	Vent plug ⅛" NPT	Steel	6K1				
3	Elbow connector - tubing	Polypropylene	6K94				
4	Casing	Cast iron	1K342		1K382	1K342	
5	Nozzle	Delrin®	AN018	AN020	AN018		
6	Venturi tube	Lexan®	AD3330	AD3325	AD3330	AD3336	AD3339
7	Separator plate seal ring	BUNA-N	5K323				
8	Separator plate	Polypropylene	5K253				
9	Diffuser (guidevane)	Lexan®	3K64			3K65	
10	Impeller	Noryl®	2K900			2K901	2K902
11	O-ring	BUNA	5K230				
12	Mechanical seal - Rotary	Teepelite	10K10				
13	Mechanical seal - Stationary	Ceramic	10K10				
14	Seal housing	Amodel®	1K366				
15	Connector with locknut	Steel	6K24				
16	Pressure switch	NA	AS4				
17	Tubing - pressure switch	Polypropylene	6K92			6K101	6K108
18	Motor	Stainless steel shaft	SFJ04860			SFJ05860	SFJ06860
19	Hex cap screw	Steel	13K80				
20	Grommet - base	BUNA	4K405				
21	Base - JRS5, JRS7, JRS10 (off tank)	Steel	4K399	4K449	4K399		
	Tank base - JRS5LT (on tank model)						
22	Discharge gland washers (pkg 2)	N-8090	-	5K10	-		
23	Discharge gland packing	BUNA	-	5K8	-		
24	Dis. gland nut assembly (includes 22 & 23)	Brass	-	4K12	-		

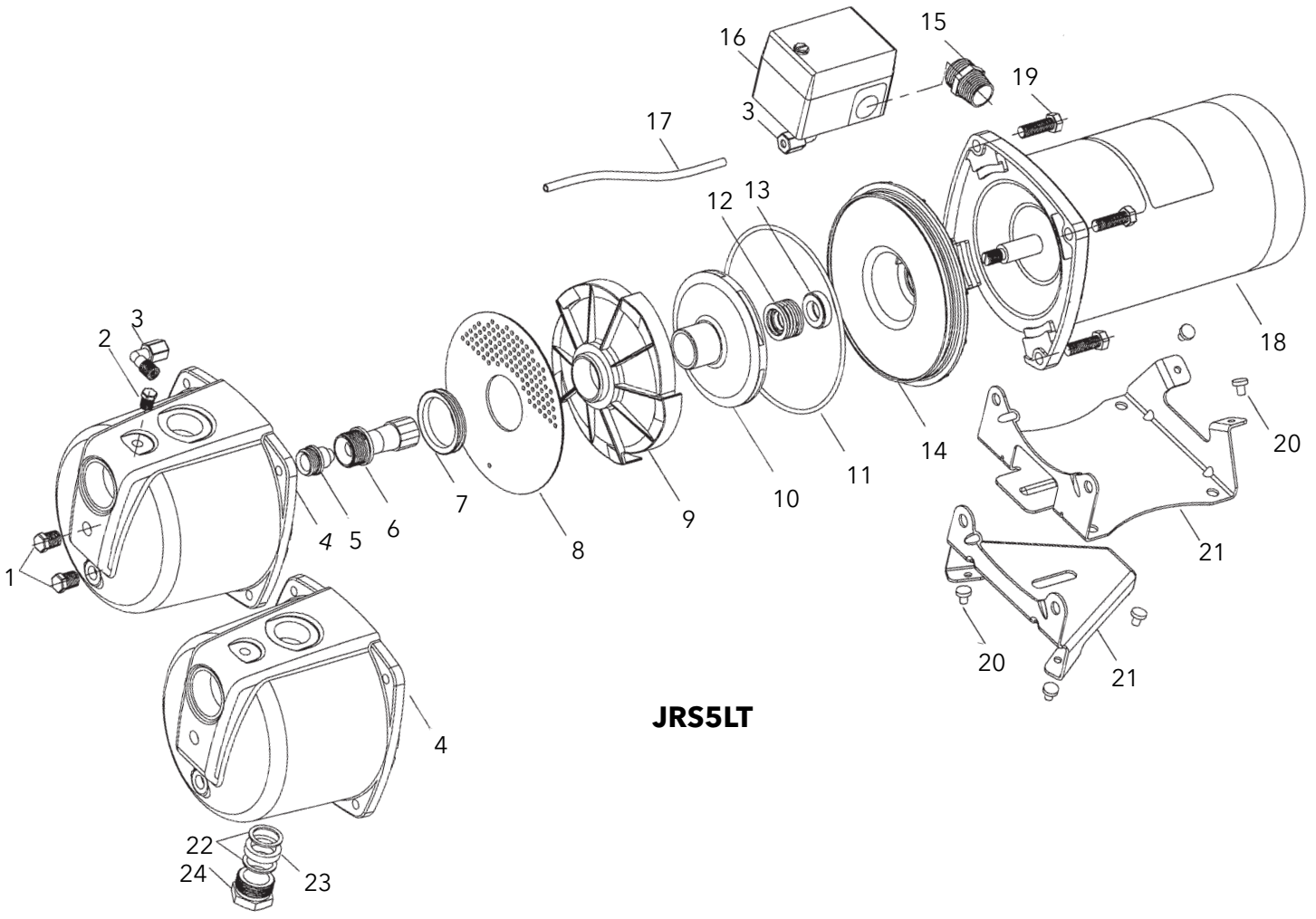

JRS5LT

Xylem Inc.
 2881 East Bayard Street Ext., Suite A, Seneca Falls, NY 13148
 Phone: (866) 325-4210 Fax: (888) 322-5877
www.xylem.com/brands/gouldswatertechnology



Goulds is a registered trademark of Goulds Pumps, Inc. and is used under license.
 © 2012 Xylem Inc. RJRS R1 August 2012